

Supply 230 volt 50 Hz
or from Box for Electric heater page 3

Wiring diagram for Turborex TX 3100A Mainboard

Dato: 2017.02.02
diagram 2 of 4 Ver. 3.0
Copyright ©

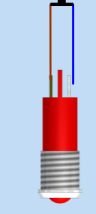
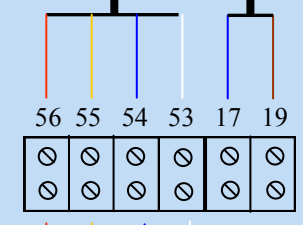
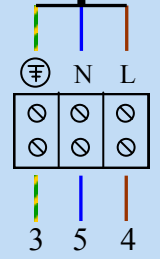

Temperature sensor
 T1 = fresh air (outside the top cone)
 T2 = Supply air (In the bottom cone)
 T3 = Extract (behind service hatch)
 T4 = Exhaust air (inside the top cone)

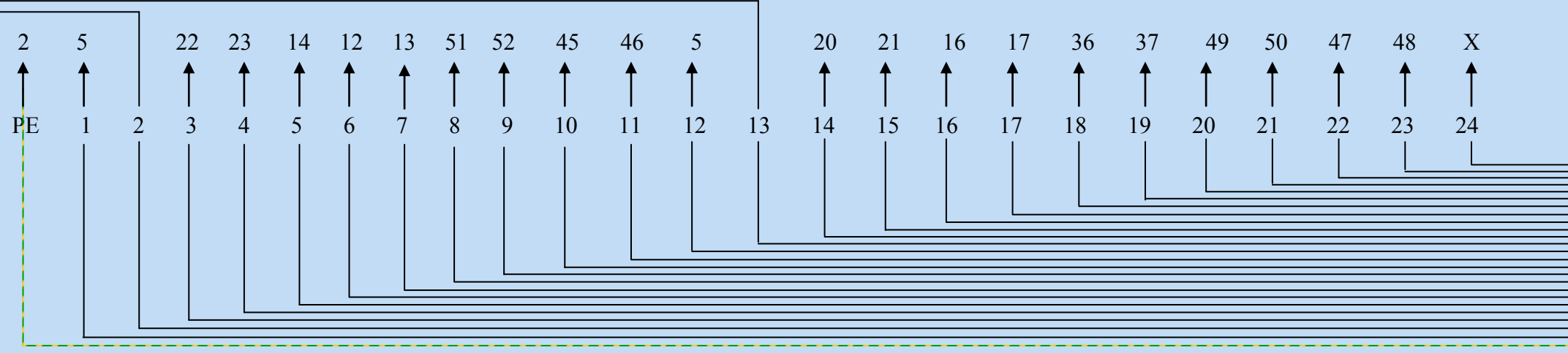
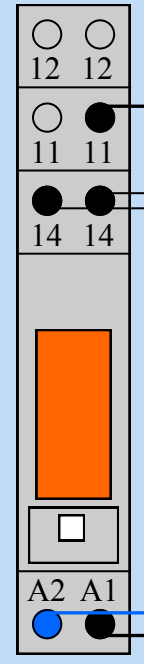
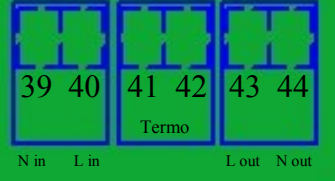
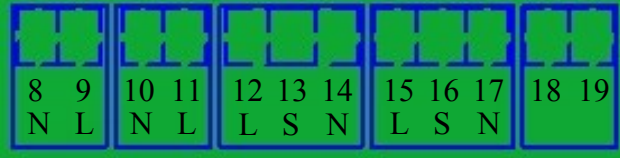
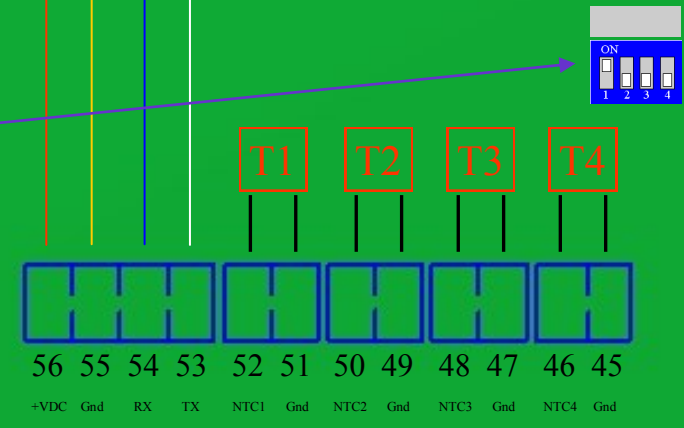
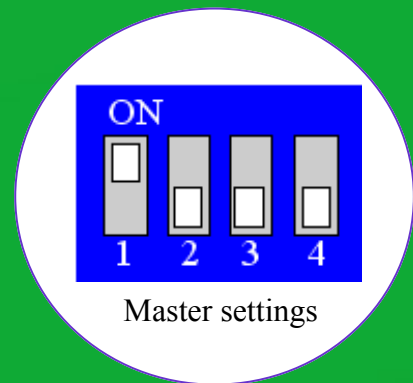

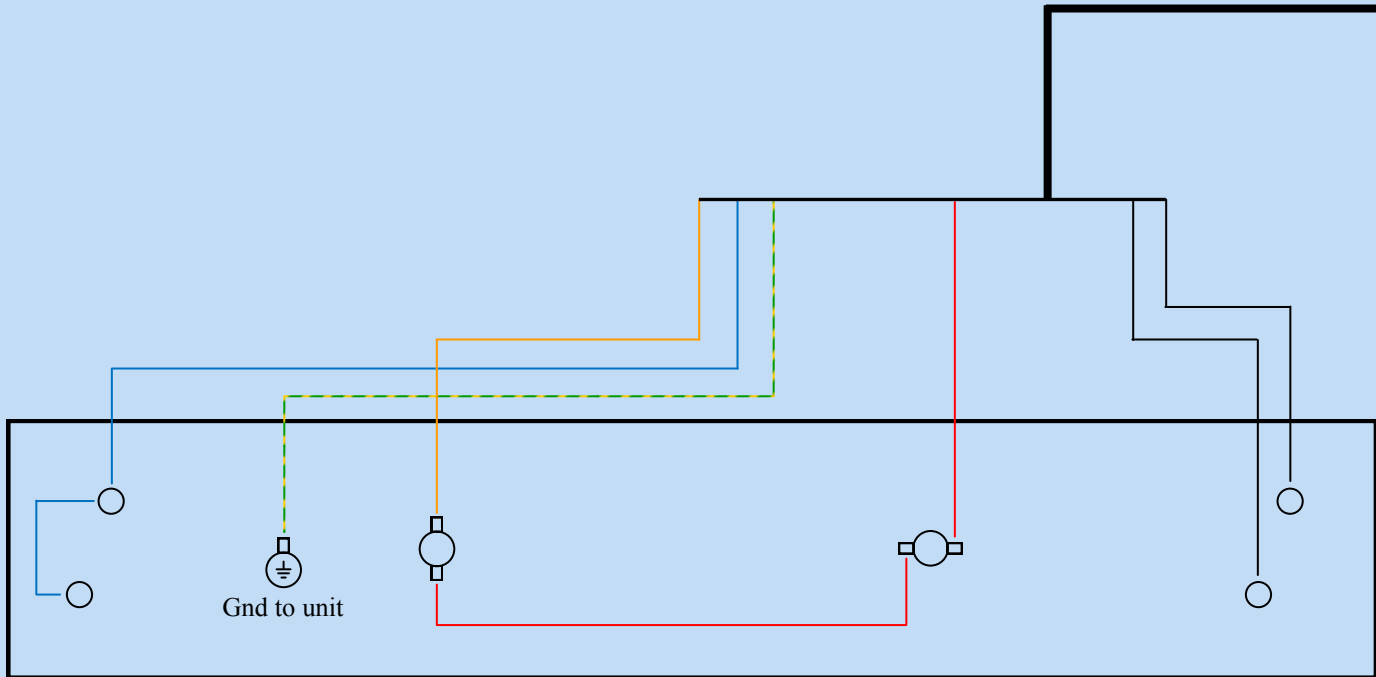

Electric heater

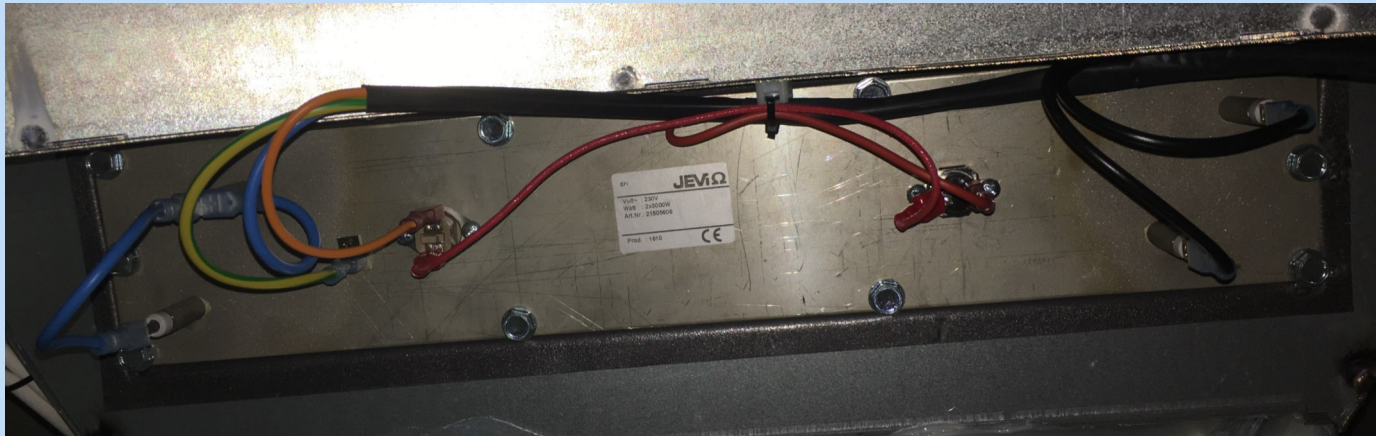

Electric heater foto

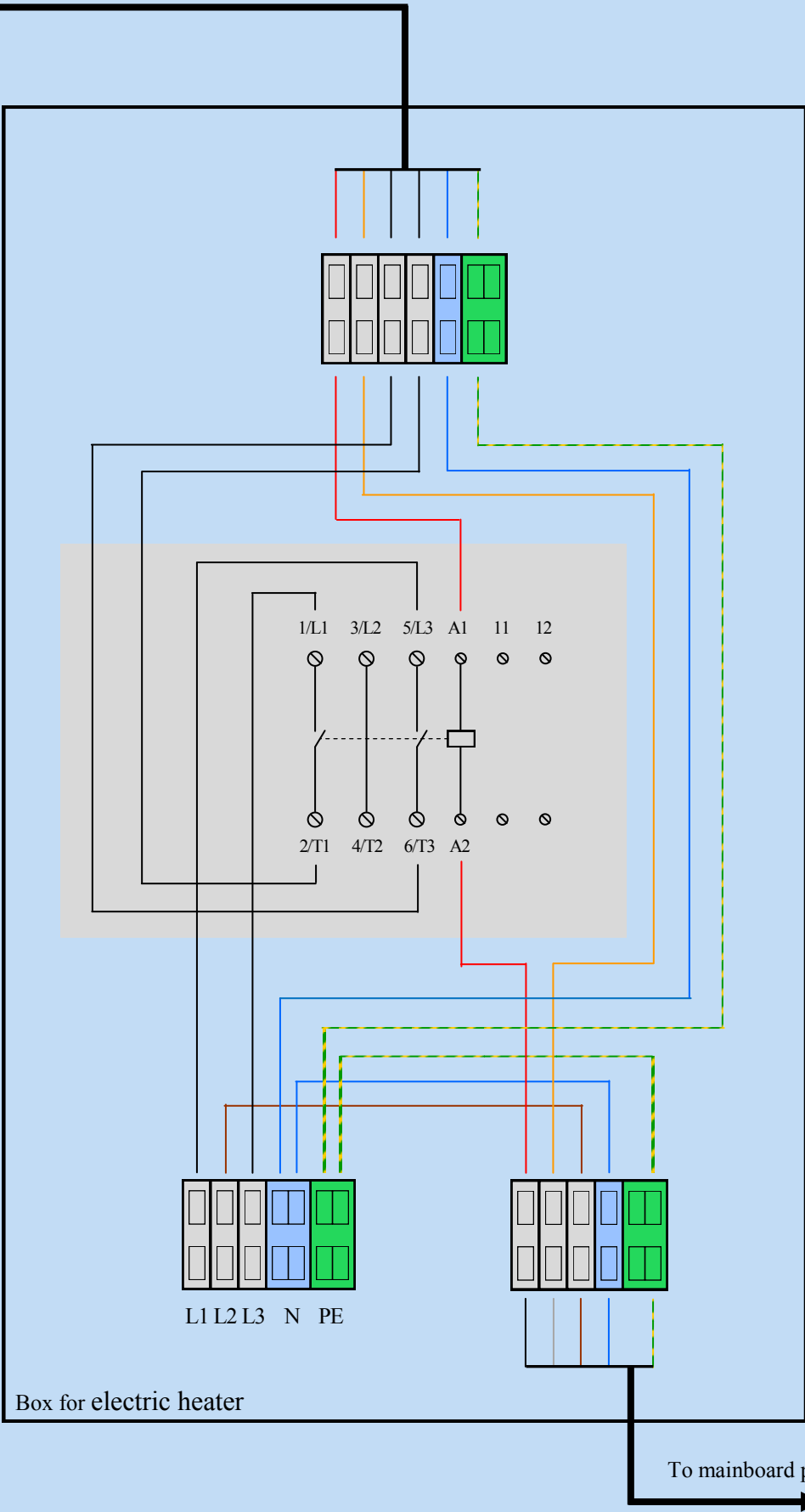

Box for electric heater

To mainboard page2

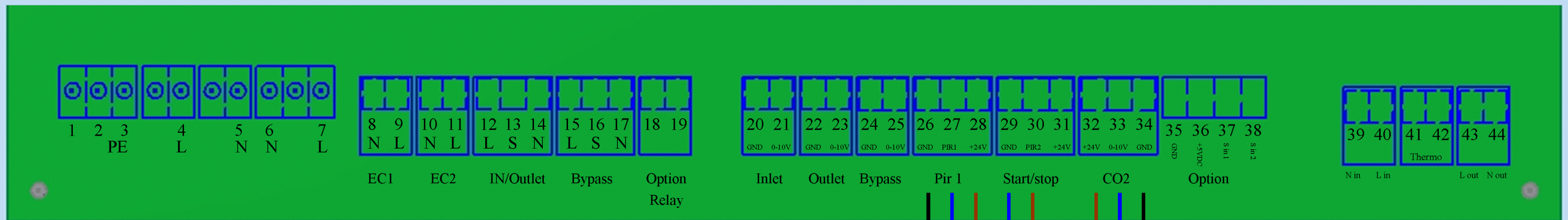

PIR / Hygrostat

Setup and operation of sensor

To operate with the sensor, system must be started as a PIR-operation

Setup und Betrieb des Sensors

Um mit dem Sensor-System ausgeführt werden muss als PIR-Operation gestartet werden.

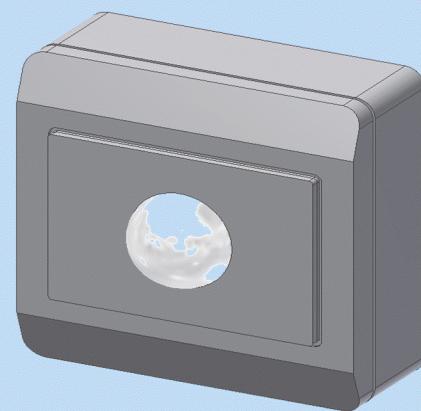
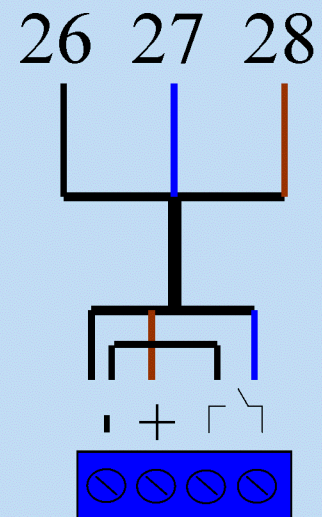

PIR

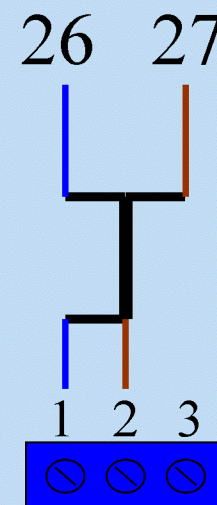

Hygrostat

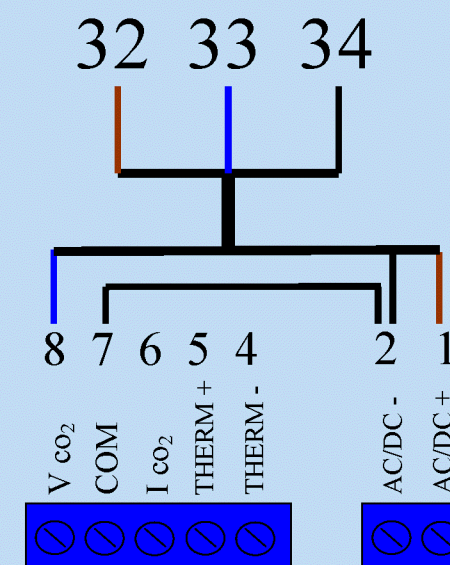

CO2